

- NOTES
1. Minimum 100mm.
 2. Pair of vertical-headed pilasters.
 3. Unfinished corridor that books into side chamber Fa of KV 11.

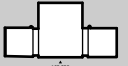

Theban
 Project
KV 11 - Ramesses III
 Plan sections 1:125
 Dyn. XX
 Sheet 26/72 - KV 11 (1/2)

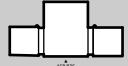
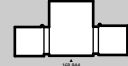
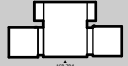
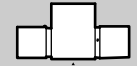
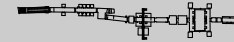
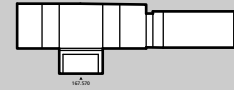
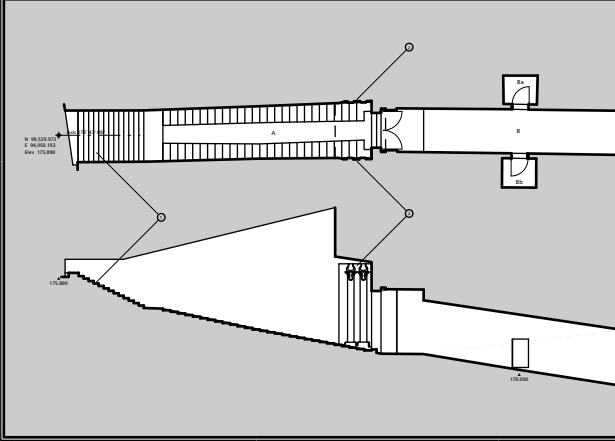
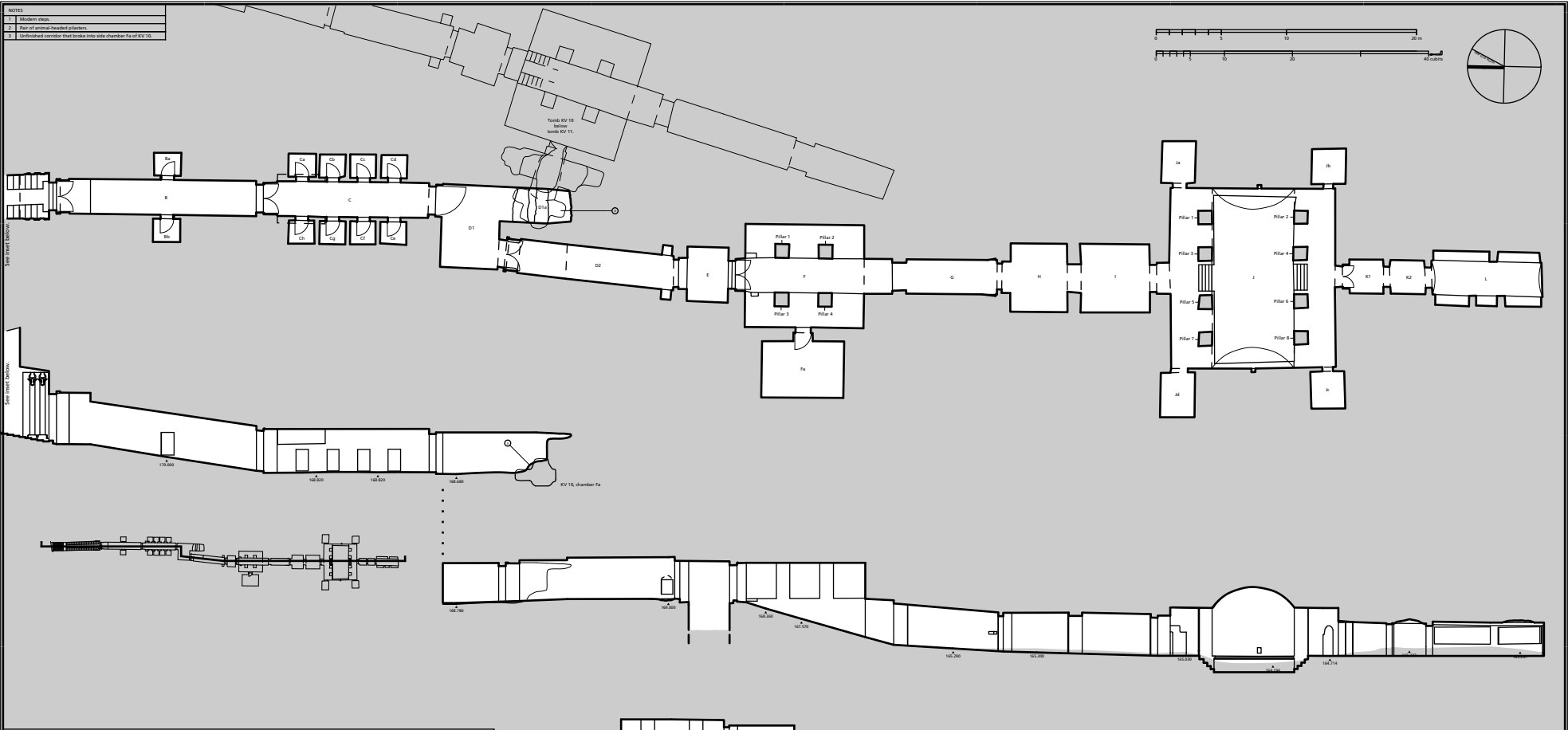
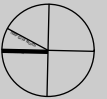